

AIR PREPARATION UNITS

PRECISION REGULATOR - 1/2 Series PR

Cat No PR - 01 - 02

PRECISION REGULATOR - 1/2

Features

- Precise pressure control
- Characteristics such as flow characteristic, pressure characteristic and repeatability are superior compared with standard regulators
- Excellent relief flow characteristic is available
- Suitable for Panel & Modular mountings
- Diaphragm operated, relieving type (Exhaust)
- Clamp and pressure gauge can be mounted either in the front or the back
- Can be assembled with F15, FRC15, FS15 & L15 series of products



Applications

Some of the applications of precision regulator,

1. Air gauging equipment
2. Medical equipments
3. Leak testing equipment
4. Polishing machinery
5. Web tensioning
6. Measuring machines
7. Ink or paint, Robotics spraying systems
8. Tank blanketing and many...

Technical Specifications

| Model | PR15631 | PR15632 | PR15633 |
|--|--|---------|---------|
| Port size | G1/2 | | |
| Pressure gauge port size | G1/8 & G1/4 | | |
| Medium | Compressed, Filtered, Non lubricated air | | |
| Maximum supply pressure (bar) | 10 | | |
| Minimum supply pressure ¹ (bar) | Set pressure +1 | | |
| Regulating pressure range (bar) | 0.1 - 2 | 0.1 - 4 | 0.1 - 8 |
| Sensitivity | Within 0.2% of full span ² | | |
| Repeatability | Within ±0.5% of full span ² | | |
| Air consumption ³ | a) Bleed hole - 9.5 lts / min (Supply pressure - 10 bar), b) Exhaust port - 2 lts / min (at maximum set pressure) | | |
| Flow (lts / min) | Refer graph | | |
| Ambient temperature | -10° to +60° C | | |
| Medium temperature | +5° to +50° C | | |
| Materials of construction | Aluminium, SS, Brass, Celcon, Steel, NBR | | |
| Weight (Kg) | 0.800 | | |

1 - With the condition of no flow on the outlet side. The minimum differential pressure from setting pressure should be always +1 bar.

2 - Full span - Maximum setting pressure of the product.

3 - Air is being exhausted to the atmosphere.

AIR PREPARATION UNITS

PRECISION REGULATOR - 1/2 Series PR

Cat No PR - 01 - 02

Dimension

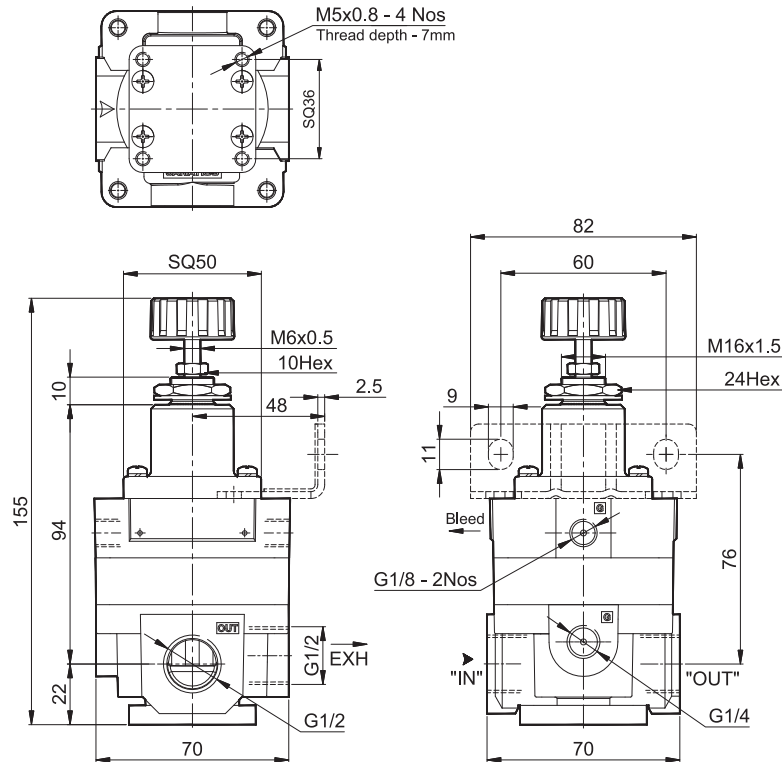

Accessories

| CLAMP | PRESSURE GAUGE | | | | | | | | | | |
|---------------------------|---|--------------------|--------------|-------|--------|-------|--------|-------|--------|--------|--------|
| <p>Ordering No. A2C06</p> | <table border="1"> <thead> <tr> <th>Pressure range bar</th> <th>Ordering No.</th> </tr> </thead> <tbody> <tr> <td>0 - 4</td> <td>A2PG04</td> </tr> <tr> <td>0 - 6</td> <td>A2PG06</td> </tr> <tr> <td>0 - 8</td> <td>A2PG08</td> </tr> <tr> <td>0 - 16</td> <td>A2PG16</td> </tr> </tbody> </table> | Pressure range bar | Ordering No. | 0 - 4 | A2PG04 | 0 - 6 | A2PG06 | 0 - 8 | A2PG08 | 0 - 16 | A2PG16 |
| Pressure range bar | Ordering No. | | | | | | | | | | |
| 0 - 4 | A2PG04 | | | | | | | | | | |
| 0 - 6 | A2PG06 | | | | | | | | | | |
| 0 - 8 | A2PG08 | | | | | | | | | | |
| 0 - 16 | A2PG16 | | | | | | | | | | |

How to order : Mention the ordering number required, Example :- Clamp - Ordering no : **A2C06**

Precautions

1. If the supply pressure line contains drainage or dirt, etc., the disc can become clogged leading to malfunction, and therefore, in addition to an air filter be sure to use a mist separator.
2. Never use a lubricator on the supply side of the regulator, as this will positively cause the disc to become clogged and lead to malfunction. If lubrication is required for terminal devices, connect a lubricator on the output side of the regulator.
3. Do not use a precision regulator outside the range of its specifications as this can cause failure. (Refer to technical specifications)
4. When mounting is performed, make connections while confirming port indications.
5. Air is normally released from the bleed hole. This is a necessary consumption of air based on the construction of the precision regulator, and is not an abnormality.
6. Make sure to tighten the lock nut after pressure adjustment.
7. The supply pressure is relatively high (approx. 5bar or more), the set pressure is low (approx. 1bar or less), and when operated with the output side released to the atmosphere, there may be pulsations in the setting side pressure. In this kind of situation, operate with the supply pressure reduced as much as possible, or increase the set pressure somewhat and restrict the output line.
8. The capacity of the output side is large, and when used for the purpose of a relief function, the exhaust sound will be loud when being relieved. Therefore, operate with a silencer mounted on the exhaust port (EXH port). The connection is G1/2.

AIR PREPARATION UNITS

PRECISION REGULATOR - 1/2 Series PR

Cat No PR - 01 - 02

Flow Graphs - 1/2

Flow Characteristics

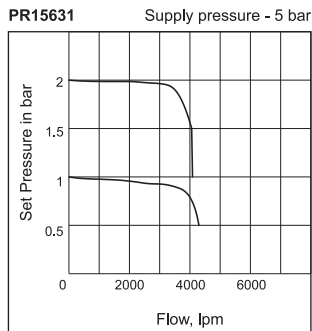
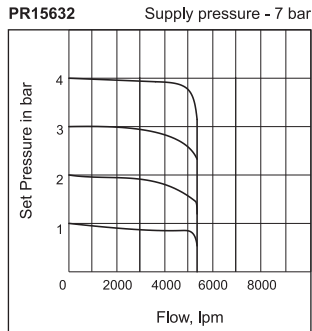
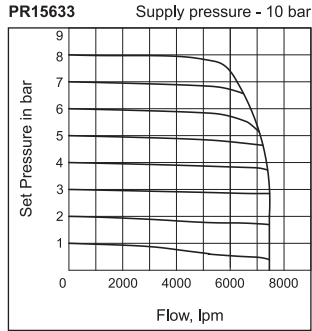

Relief Characteristics

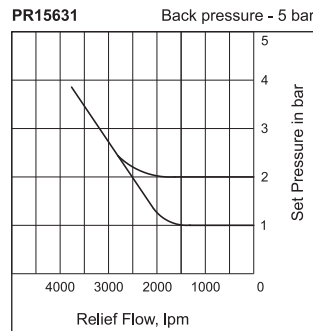
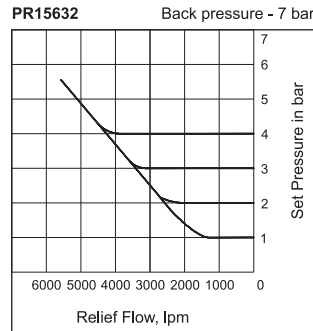
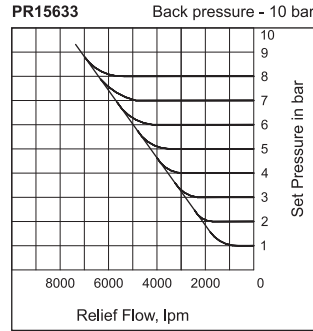

Pressure Characteristics

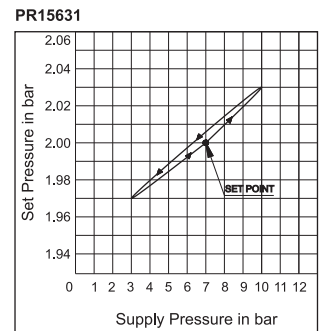
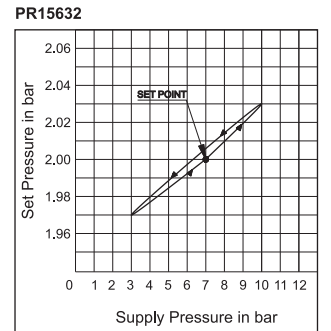
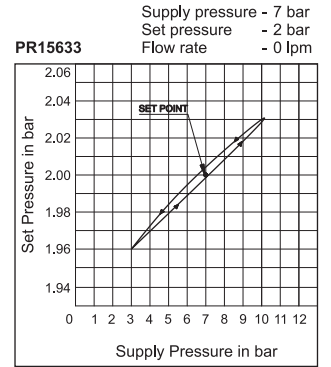

How to order

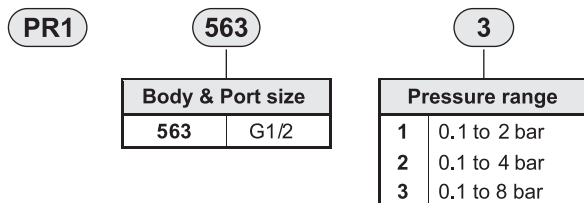

Ordering example:

Precision Regulator - 1/2 size (with G1/2 port), with pressure range 0.1 to 8 bar - Ordering No: **PR15633**